



MAGNETIC TRACKLIGHT

LAMBARIO . . .
Brighter moments

48V PRODUCTS

Choose your right
product



For more information visit
www.lambario.com

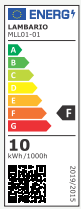
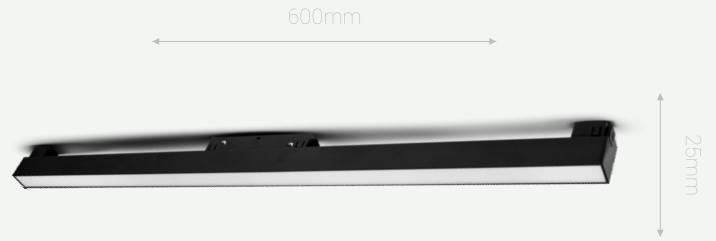
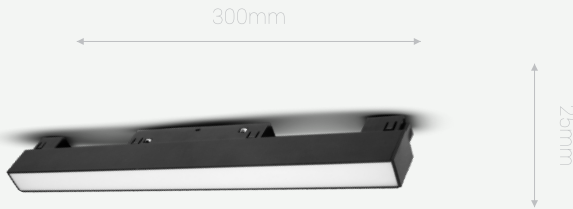

LUMEN: 537 Lm
WATT: 10W
VOLTAGE: 48V
CCT: 3000K
MATERIAL: AL-PC
8605036611644

MLL01-01 PRICE: **19.00**

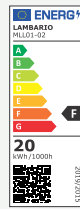

LUMEN: 1129 Lm
WATT: 20W
VOLTAGE: 48V
CCT: 3000K
MATERIAL: AL-PC
8605036611651

MLL01-02 PRICE: **25.90**



LUMEN: 1614 Lm
WATT: 36W
VOLTAGE: 48V
CCT: 3000K
MATERIAL: AL-PC
8605036611668

MLL01-03 PRICE: **36.30**



LUMEN: 2415 LM
WATT: 40W
VOLTAGE: 48V
CCT: 3000K
MATERIAL: AL+PC
8605036611675

MLL01-04 PRICE: **44.80**



Technical information above may have tolerance +10%.For final update information please visit website



LUMEN: 494 LM | CCT: 3000K
WATT: 6W | MATERIAL: AL+PC
VOLTAGE: 48V | 8605036611682

MLL01-05

PRICE: **16.58**



LUMEN: 970 LM | CCT: 3000K
WATT: 12W | MATERIAL: AL+PC
VOLTAGE: 48V | 8605036611699

MLL01-06

PRICE: **21.85**



LUMEN: 1429 LM | CCT: 3000K
WATT: 18W | MATERIAL: AL+PC
VOLTAGE: 48V | 8605036611705

MLL01-07

PRICE: **28.60**



LUMEN: 2111 Lm | CCT: 3000K
WATT: 24W | MATERIAL: AL-PC
VOLTAGE: 48V | 8605036611712

MLL01-08

PRICE: **33.60**



LAMBARIO . . .
Brighter moments

MLL01-01

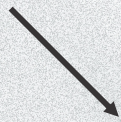

MLL01-06

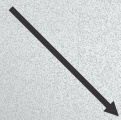

MAGNETIC
TRACKLIGHT



LUMEN: 1211 Lm | CCT: 3000K
WATT: 20W | MATERIAL: AL-PC
VOLTAGE: 48V | 8605036611729
MLL01-09 | PRICE: **40.50**

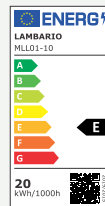

LUMEN: 1080LM | CCT: 3000K
WATT: 20W | MATERIAL: AL+PC
VOLTAGE: 48V | 8605036611736
MLL01-10 | PRICE: **40.50**



LUMEN: 963LM | CCT: 3000K
WATT: 12W | MATERIAL: AL+PC
VOLTAGE: 48V | 8605036611750
MLL01-12 | PRICE: **34.50**

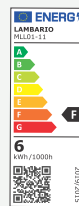

LUMEN: 246 LM | CCT: 3000K
WATT: 6W | MATERIAL: AL+PC
VOLTAGE: 48V | 8605036611743
MLL01-11 | PRICE: **23.50**



Technical information above may have tolerance +10%. For final update information please visit website



LUMEN: 814 LM
WATT: 12W
VOLTAGE: 48V

CCT: 3000K
MATERIAL: AL+PC
8605036611774

MLL01-14

PRICE: **28.50**

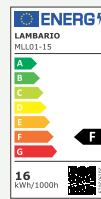

LUMEN: 1069 LM
WATT: 16W
VOLTAGE: 48V

CCT: 3000K
MATERIAL: AL+PC
8605036611781

MLL01-15

PRICE: **34.50**



LUMEN: 445 LM
WATT: 7W
VOLTAGE: 48V

CCT: 3000K
MATERIAL: AL+PC
8605036611767

MLL01-13

PRICE: **26.50**



Technical information above may have tolerance +10%.For final update information please visit website



42mm



98mm

60mm



262mm

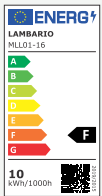

LUMEN: 1193 LM
WATT: 10W
VOLTAGE: 48V

CCT: 3000K
MATERIAL: AL+PC
8605036611798

MLL01-16

PRICE: **33.50**

2 years WARRANTY 30000 hours 24° Beam Angle **IP20**

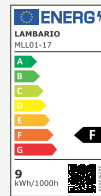

LUMEN: 708 Lm
WATT: 9W
VOLTAGE: 48V

CCT: 3000K
MATERIAL: AL-PC
8605036611804

MLL01-17

PRICE: **28.50**

2 years WARRANTY 30000 hours 24° Beam Angle **IP20**

1000mm

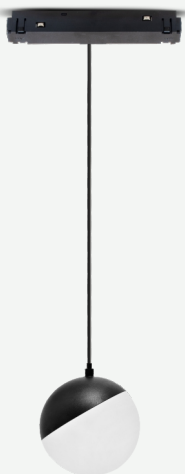

90mm

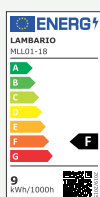

LUMEN: 716 Lm
WATT: 9W
VOLTAGE: 48V

CCT: 3000K
MATERIAL: AL-PC
8605036611811

MLL01-18

PRICE: **56.00**

2 years WARRANTY 30000 hours 24° Beam Angle **IP20**

Technical information above may have tolerance +10%. For final update information please visit website

LAMBARIO . . .

Brighter moments



MLL01-11

MLL01-06

MLL01-17

MLL01-07

**MAGNETIC
TRACK
LIGHT**

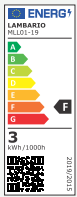

LUMEN: 158 Lm | CCT: 3000K
WATT: 3W | MATERIAL: AL-PC
VOLTAGE: 48V | 8605036611828

MLL01-19

PRICE: **16.60**



LUMEN: 831 LM | CCT: 3000K
WATT: 10W | MATERIAL: AL+PC
VOLTAGE: 48V | 8605036611835

MLL01-20

PRICE: **38.00**



LUMEN: 1547LM | CCT: 3000K
WATT: 20W | MATERIAL: AL+PC
VOLTAGE: 48V | 8605036611842

MLL01-21

PRICE: **48.00**



LUMEN: 2214 LM | CCT: 3000K
WATT: 30W | MATERIAL: AL+PC
VOLTAGE: 48V | 8605036611859

MLL01-22

PRICE: **58.00**



Technical information above may have tolerance +10%.For final update information please visit website



TYPE: SURFACE

WATT: 24W

CCT: 3000K

MLL01-23

MATERIAL: ALU

DIMENSION: EHSP

PROTECTION CLASS: III

8605036612658

PRICE: **85.00**

2 years WARRANTY 30000 hours 120° Beam Angle **IP20**



TYPE: SURFACE

WATT: 24W

CCT: 3000K

MLL01-24

MATERIAL: ALU

DIMENSION: EHSP

PROTECTION CLASS: III

8605036612665

PRICE: **132.00**

2 years WARRANTY 30000 hours 120° Beam Angle **IP20**

LAMBARIO . . .
Brighter moments

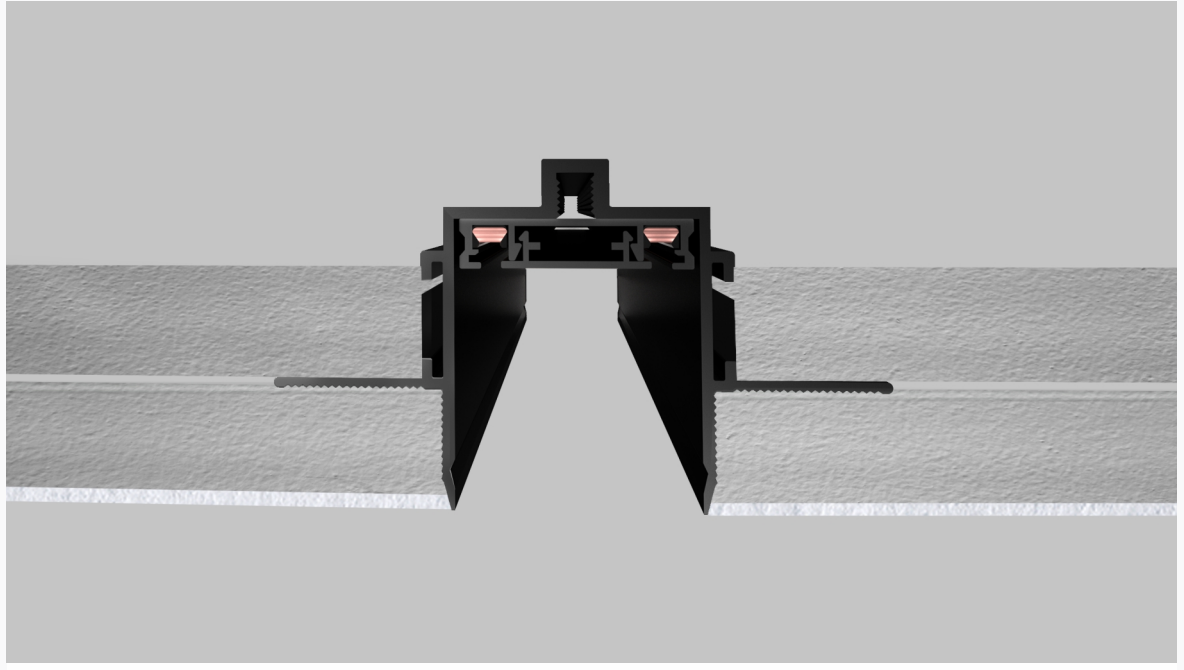

MAGNETIC
TRACKLIGHT
ACCESORIES

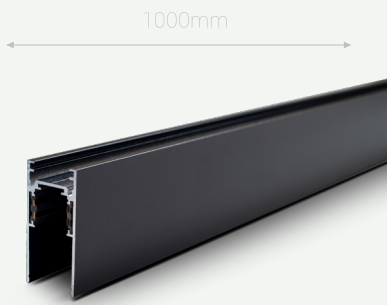

TYPE: SURFACE
LENGTH : 1000MM
COLOR: BLACK

PROTECTION CLASS: II
MATERIAL: ALU
8605036611866

MAL01-01

PRICE: **17.80**

2^{years} WARRANTY **IP20**

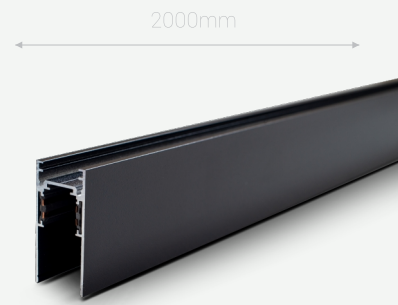

TYPE: SURFACE
LENGTH : 2000MM
COLOR: BLACK

PROTECTION CLASS: II
MATERIAL: ALU
8605036611873

MAL01-02

PRICE: **35.40**

2^{years} WARRANTY **IP20**

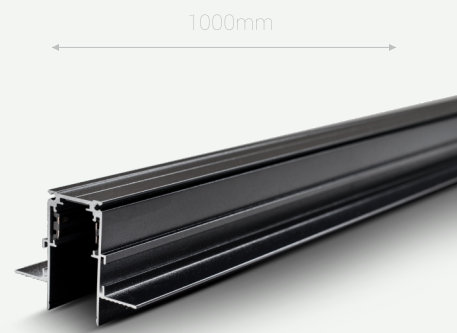

TYPE: CEILING
LENGTH : 1000MM
COLOR: BLACK

PROTECTION CLASS: II
MATERIAL: ALU
8605036611897

MAL01-04

PRICE: **22.00**

2^{years} WARRANTY **IP20**

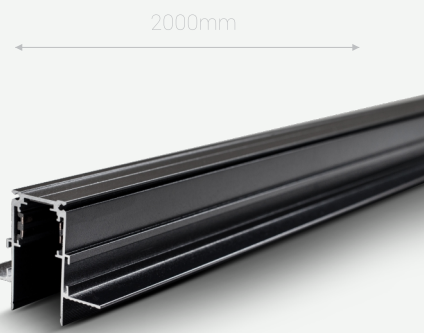

TYPE: CEILING
LENGTH : 2000MM
COLOR: BLACK

PROTECTION CLASS: II
MATERIAL: ALU
8605036611903

MAL01-05

PRICE: **42.00**

2^{years} WARRANTY **IP20**



TYPE: RECESSED
LENGTH : 1000MM
COLOR: BLACK

PROTECTION CLASS: II
MATERIAL: ALU
8605036611927

MAL01-07

PRICE: **18.60**

2^{years} WARRANTY **IP20**

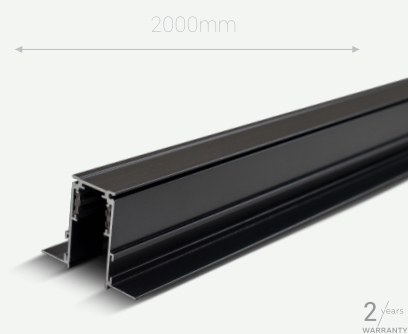

TYPE: RECESSED
LENGTH : 2000MM
COLOR: BLACK

PROTECTION CLASS: II
MATERIAL: ALU
8605036611934

MAL01-08

PRICE: **37.20**

2^{years} WARRANTY **IP20**

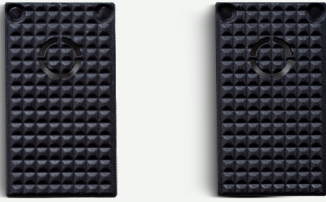

2 years WARRANTY **IP20**

TYPE: CAPS
COLOR: BLACK
PROTECTION CLASS: II

MATERIAL: THERMOPC
8605036611880

MAL01-03

PRICE: **0.80**

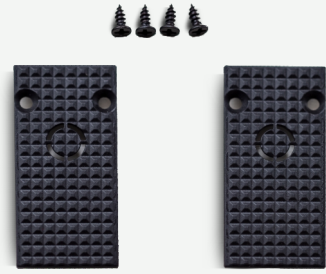

2 years WARRANTY **IP20**

TYPE: CAPS
COLOR: BLACK
PROTECTION CLASS: II

MATERIAL: THERMOPC
8605036611941

MAL01-09

PRICE: **0.65**

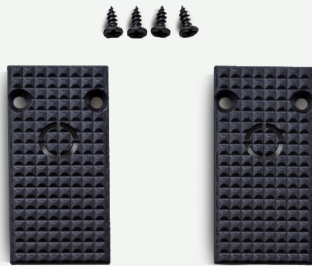

2 years WARRANTY **IP20**

TYPE: CAPS
COLOR: BLACK
PROTECTION CLASS: II

MATERIAL: THERMOPC
8605036611910

MAL01-06

PRICE: **0.65**

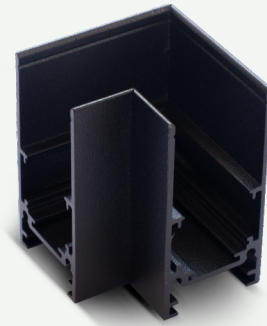

2 years WARRANTY **IP20**

TYPE: SURFACE CORNER
COLOR: BLACK

PROTECTION CLASS: II
MATERIAL: ALU
8605036611958

MAL01-10

PRICE: **5.50**

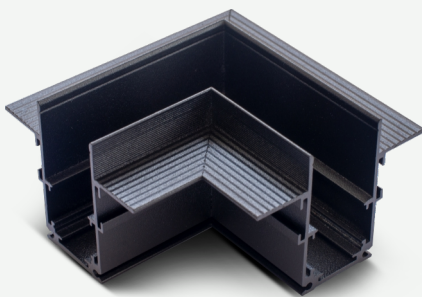

2 years WARRANTY **IP20**

TYPE: CORNER
COLOR: BLACK

PROTECTION CLASS: II
MATERIAL: ALU
8605036611965

MAL01-11

PRICE: **5.88**

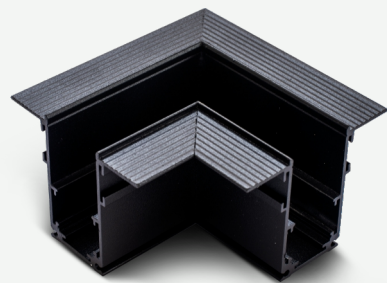

2 years WARRANTY **IP20**

TYPE: CORNER
COLOR: BLACK

PROTECTION CLASS: II
MATERIAL: ALU
8605036611972

MAL01-12

PRICE: **5.88**

Technical information above may have tolerance +10%.For final update information please visit website

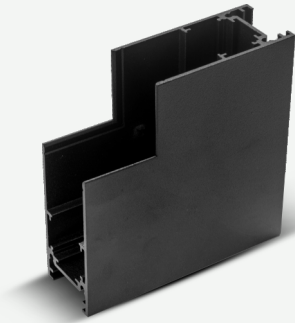

TYPE: INTERNAL CORNER
COLOR: BLACK

CCT: 3000K
MATERIAL: AL+PC
8605036611989

MAL01-13

PRICE: **5.50**

2 years WARRANTY **IP20**

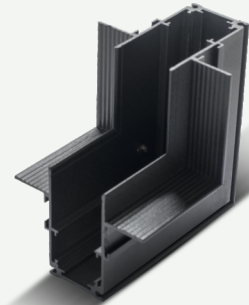

TYPE: INTERNAL CORNER
COLOR: BLACK

PROTECTION CLASS: III
MATERIAL: ALU
8605036611996

MAL01-14

PRICE: **5.88**

2 years WARRANTY **IP20**

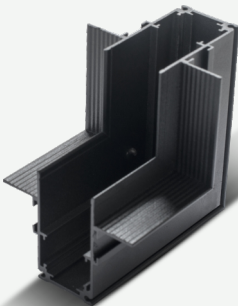

TYPE: INTERNAL CORNER
COLOR: BLACK

PROTECTION CLASS: III
MATERIAL: ALU
8605036612009

MAL01-15

PRICE: **5.88**

2 years WARRANTY **IP20**



TYPE: CONNECTOR
INPUT MODULE 3
COLOR: BLACK

MAL01-18

PROTECTION CLASS: II
MATERIAL: ALU+PC
8605036612030

PRICE: **6.50**

2 years WARRANTY **IP20**



TYPE: CONNECTOR INPUT
COLOR: BLACK

PROTECTION CLASS: II
MATERIAL: ALU+PC
8605036612047

MAL01-19

PRICE: **5.20**

2 years WARRANTY **IP20**



TYPE: POWER SUPPLY
200W | 48VOLT
COLOR: BLACK

MAL01-25

PROTECTION CLASS: II
MATERIAL: ALU+PC
8605036612108

PRICE: **35.80**

2 years WARRANTY **IP20**



TYPE: CONNECTOR
INPUT WIRE
COLOR: BLACK

MAL01-20

PROTECTION CLASS: II
MATERIAL: ALU+PC
8605036612054

PRICE: **5.85**

2/years
WARRANTY **IP20**

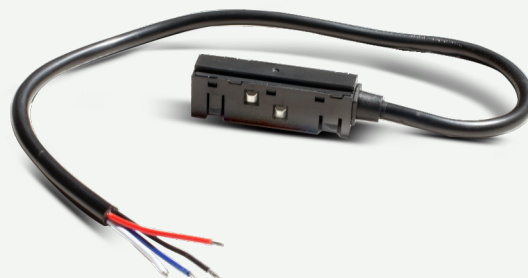

TYPE: CONNECTOR INPUT
COLOR: BLACK

MAL01-16

PROTECTION CLASS: II
MATERIAL: ALU+PC
8605036612016

PRICE: **3.90**

2/years
WARRANTY **IP20**



TYPE: CONNECTOR INPUT
COLOR: BLACK

MAL01-17

PROTECTION CLASS: II
MATERIAL: ALU+PC
8605036612023

PRICE: **7.70**

2/years
WARRANTY **IP20**



TYPE: MOUNTING
STRAIGHT METAL
COLOR: BLACK

MAL01-21

PROTECTION CLASS: II
MATERIAL: ALU+PC
8605036612061

PRICE: **1.00**

2^{years}
WARRANTY **IP20**

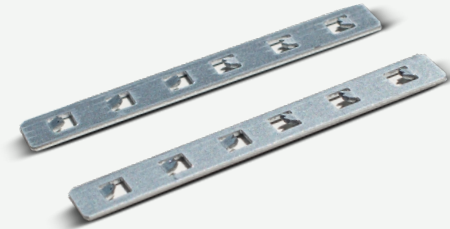

TYPE: MOUNTING
STRAIGHT METAL
COLOR: BLACK

MAL01-22

PROTECTION CLASS: II
MATERIAL: ALU
8605036612078

PRICE: **0.70**

2^{years}
WARRANTY **IP20**



TYPE: PENDANT CHAIN
COLOR: BLACK

MAL01-23

PROTECTION CLASS: II
MATERIAL: ALU
8605036612085

PRICE: **3.90**

2^{years}
WARRANTY **IP20**



TYPE: SURFACE PLANE
COLOR: BLACK

MAL01-24

PROTECTION CLASS: II
MATERIAL: ALU
8605036612092

PRICE: **1.95**

2^{years}
WARRANTY **IP20**

Choose your right
product



For more information visit
www.lambario.com

MAGNETIC TRACKLIGHT



LAMBARIO . . .
Brighter moments